



PANEL RAILTM

SYSTEM

CONTENT

PRODUCT DESCRIPTION	3
3D DRAWINGS AND ILLUSTRATIONS....	7
CORE-DRILLED CONCRETE.....	7
TOP MOUNTED TO CONCRETE	9
TOP MOUNTED TO STEEL	11
MOUNTING PANEL TO THE POST	13
MOUNTING PANEL TO THE FRAME	15
PANEL OPTIONS.....	17
AUXILLARY RAILINGS	19
LED RAILINGS	20

PRODUCT DESCRIPTION

Livers Bronze PANEL RAIL System: A versatile and stylish railing solution offering a range of panel designs

- **Design Options:** Choose from sleek, minimalist or intricate patterns to suit any architectural style or design your own patterns – Livers Bronze can customize your design solution.
- **Panel Styles:**
 - **Unframed:** Seamless, continuous pattern for a clean, modern look. Ideal for unobstructed views.
 - **Framed:** Structured appearance with framed borders for added sophistication.
- **Craftsmanship:** Durable, precision-made panels ensure both safety and style.
- **Transform Your Space:** Enhance any environment with the PANEL RAIL system's stunning visual impact.



CONTENT

3



www.liversbronze.com



Railings@LiversBronze.com



816-300-2828



PRODUCT DESCRIPTION

PANEL TYPES

Framed
Panel

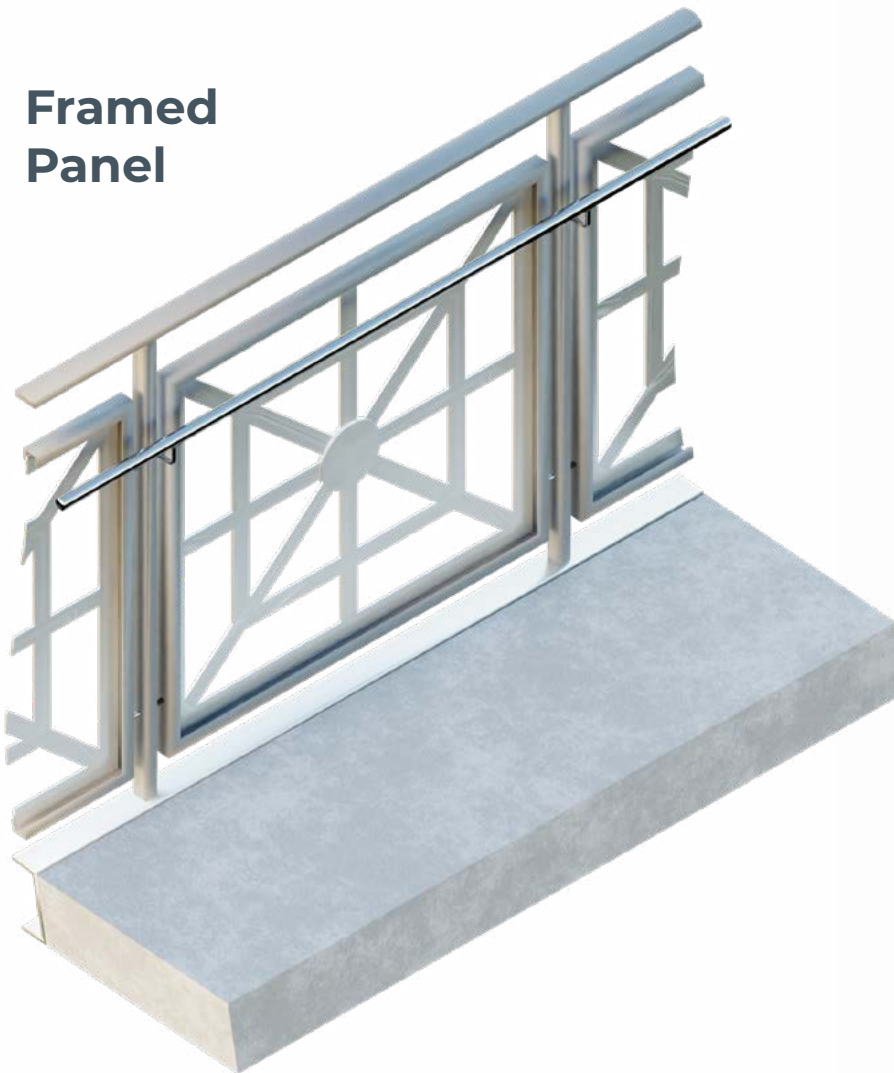

Unframed
Panel

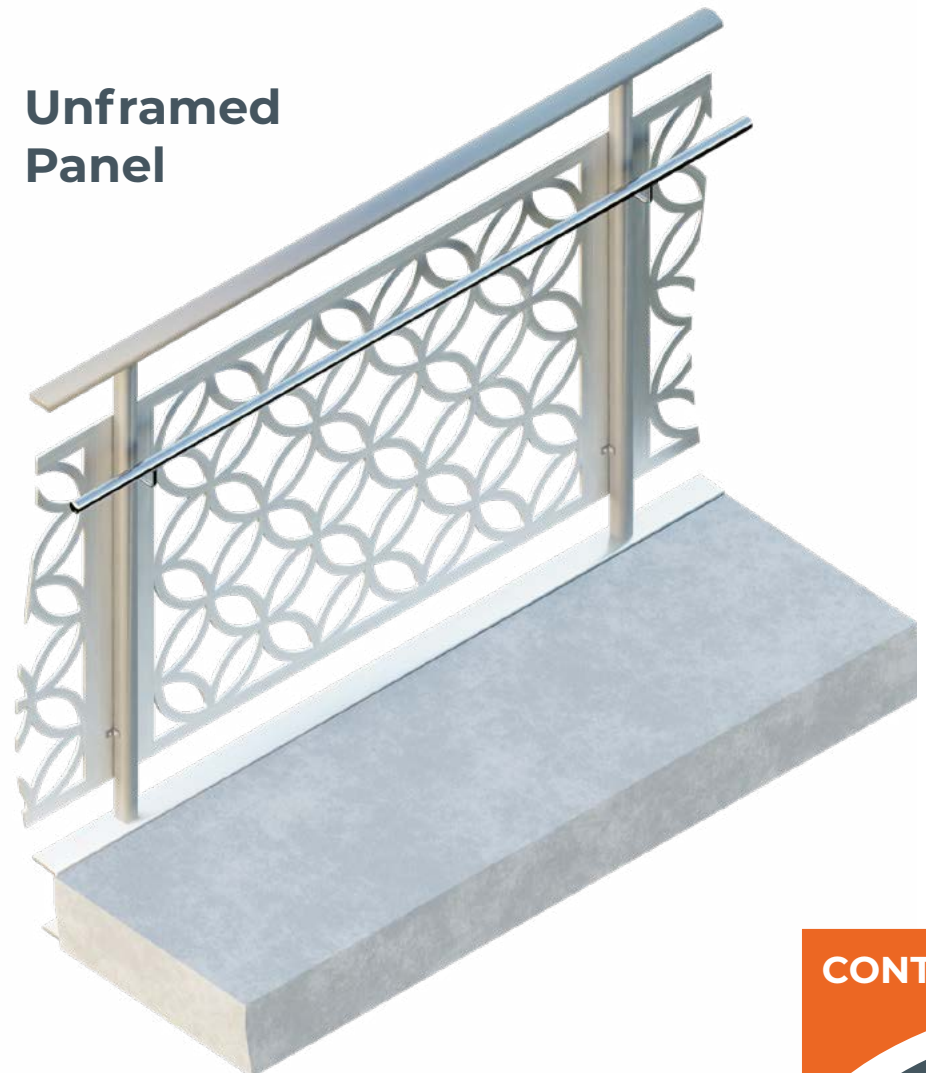

CONTENT



www.liversbronze.com



Railings@LiversBronze.com



816-300-2828

PRODUCT DESCRIPTION

	MATERIAL	FINISH	SIZE AND SPACING
POST	Aluminum	Powder Coated	2" x 3" Aluminum – max 60" oc Mounted to embedded steel, steel stair tubes/channels and concrete
INFILL	¼" aluminum cut plate – framed with an aluminum extrusion or unframed	Powder Coated	¼" Aluminum plate – cut using standard designs or custom designs. For custom designs provide SVG Vector file of patern.
TOP RAILING	Aluminum extrusion Hardwood	Powder Coated Sanded only	Continuous Railing

CONTENT

5



www.liversbronze.com



Railings@LiversBronze.com



816-300-2828

PRODUCT DESCRIPTION

	MATERIAL	FINISH	SIZE AND SPACING
HAND RAIL	Stainless Steel Tube	#4 or #6 straight grain, #6 circular grain, #7 polished, Powder Coat, Blackened	1.5" diameter tube, 2" diameter tube 1.5" diameter tube with linear LED lighting 1.5" diameter with Individual LED Puck lighting Square tubes, rectangular tubes, oval tubes are available
	Stainless Steel Bar, Steel Bar	#4 or #6 Satin, #7 Polished, Powder Coated or Blackened	Stainless Steel and Steel Bars in all available sizes
	Bronze	#4 Satin / Lacquered Polished / Lacquered Antique / Lacquered	Bronze round tubes, square tubes, rectangular tubes, bars and traditional shaped bronze extrusions. LED bronze railings are available
	Hardwood hand railings are available in all species of wood.	Sanded only – final staining and finishing is not included	Round, square and complex profiles are available. Handrail diameter minimum is 1.75" unless a metal sub-railing is provided

CONTENT



www.liversbronze.com



Railings@LiversBronze.com



816-300-2828

PANEL RAIL™
SYSTEM

**CORE-DRILLED
CONCRETE**



CONTENT



7

PANEL RAIL™ SYSTEM

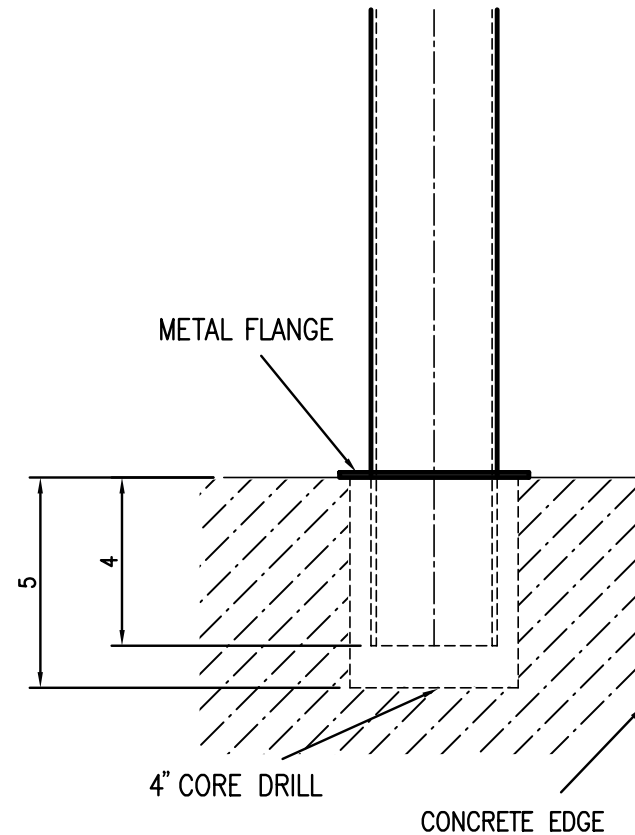
CORE-DRILLED CONCRETE



 **LIVERS**
BRONZE

 www.liversbronze.com
 Railings@LiversBronze.com
 816-300-2828

CONTENT

8

PANEL RAIL™ SYSTEM

TOP MOUNTED TO CONCRETE



CONTENT

9

LIVERS
BRONZE

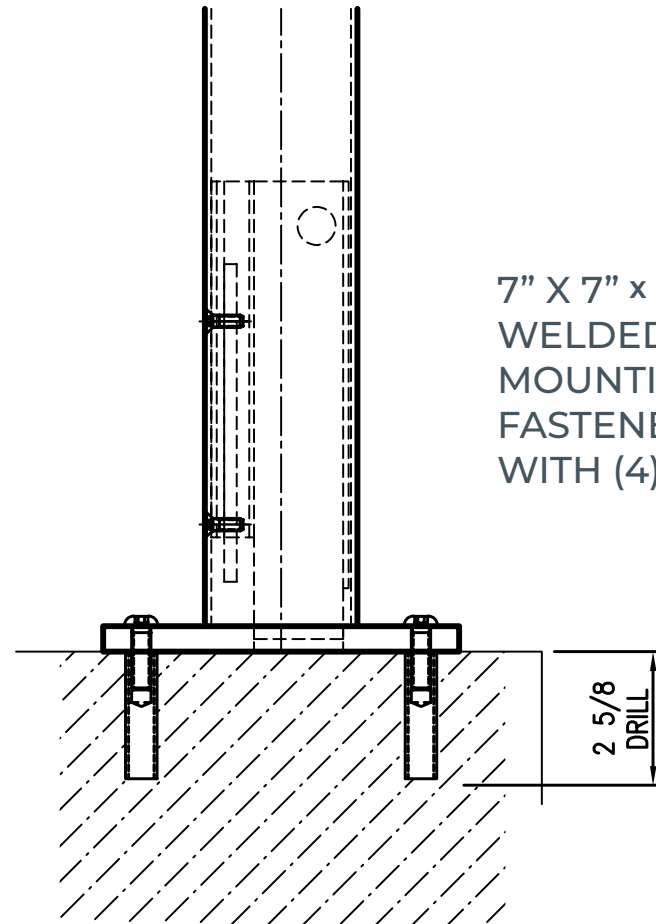
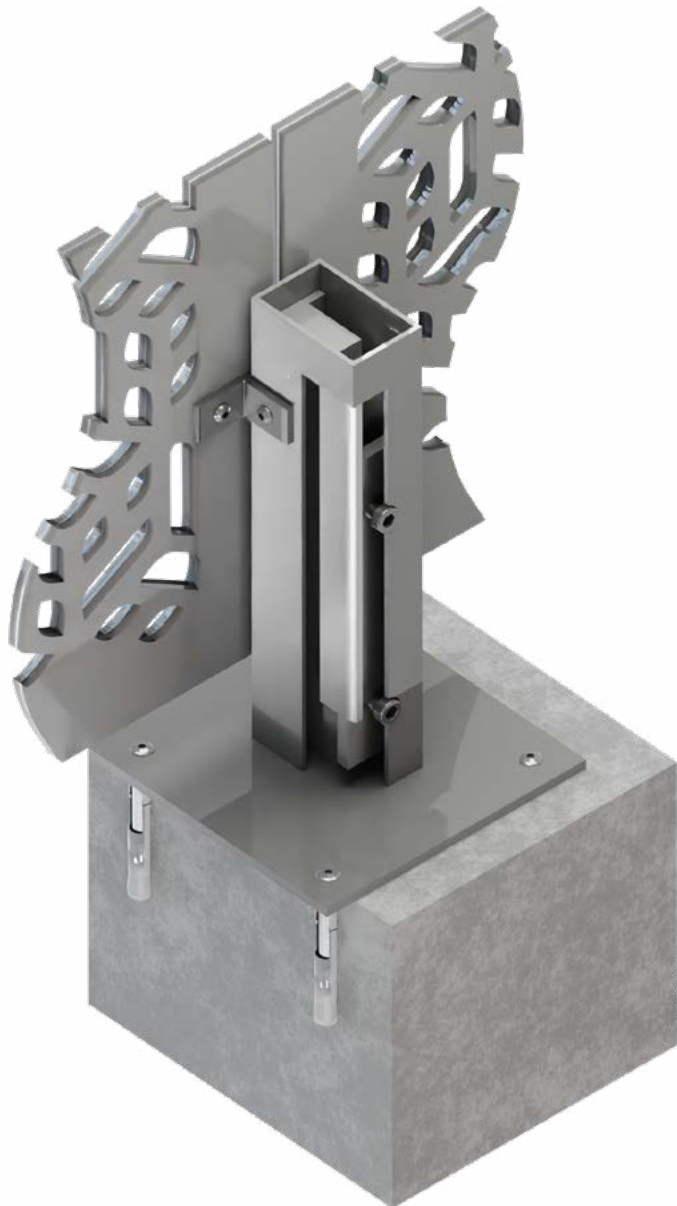

PANEL RAIL™ SYSTEM

TOP MOUNTED TO CONCRETE



7" X 7" X 1/2" METAL PLATE
WELDED TO INTERNAL
MOUNTING STUB
FASTENED TO CONCRETE
WITH (4) ANCHORS

 **LIVERS**
BRONZE

 www.liversbronze.com
 Railings@LiversBronze.com
 816-300-2828

CONTENT

10

PANEL RAIL™ SYSTEM

TOP MOUNTED TO STEEL

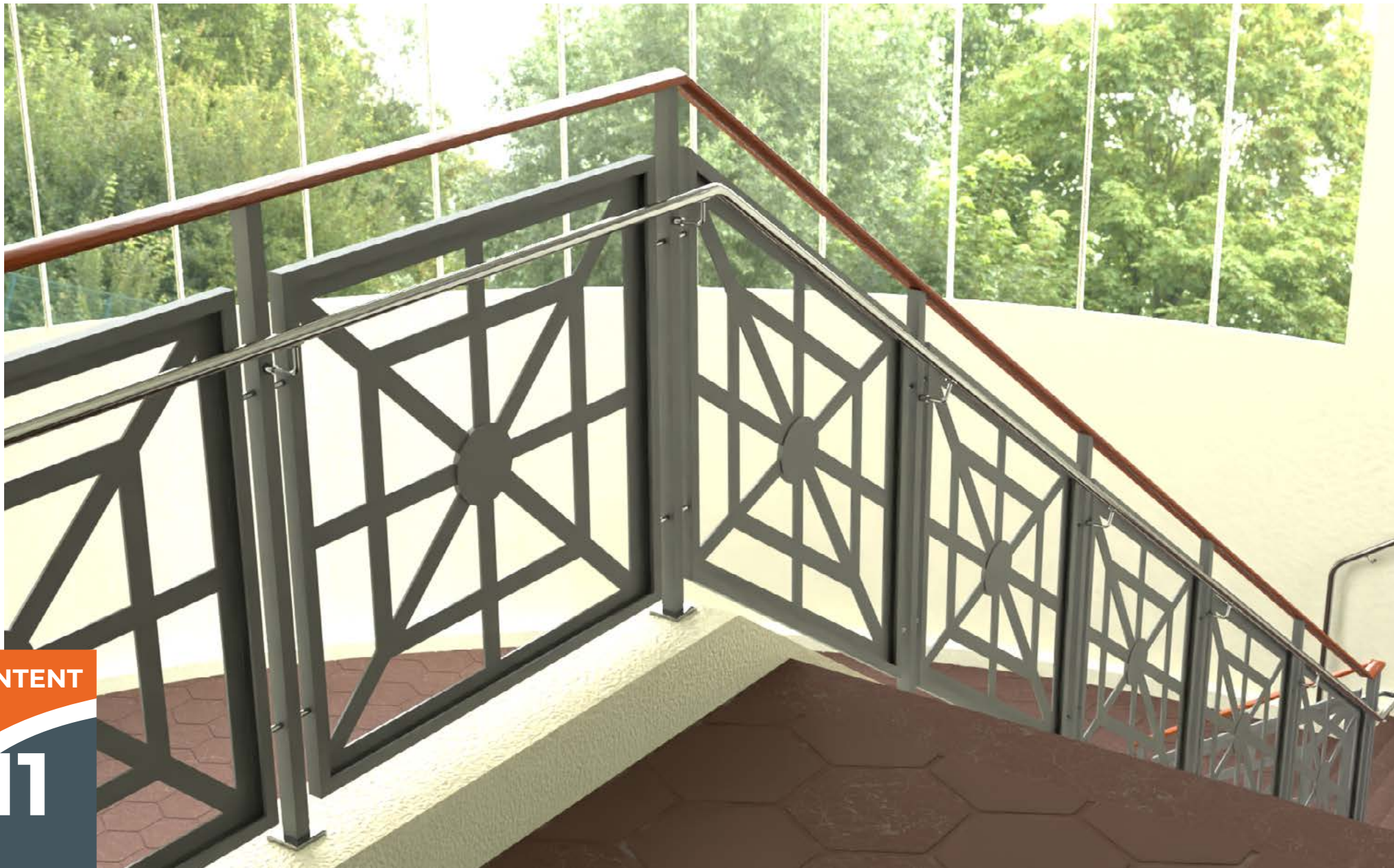

CONTENT

11

PANEL RAIL™ SYSTEM

TOP MOUNTED TO STEEL



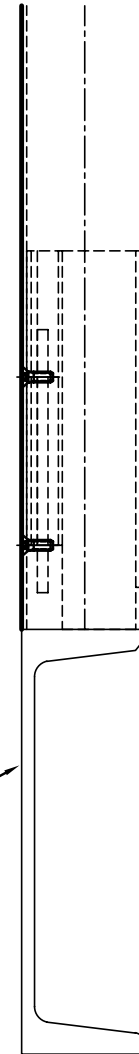

Post cut-away
showing internal
steel mounting
welded to steel
stringer

STEEL STRINGER SHOWN



 **LIVERS**
BRONZE

 www.liversbronze.com
 Railings@LiversBronze.com
 816-300-2828

CONTENT

12



FRAMELESS PANEL MOUNTING TO THE POST

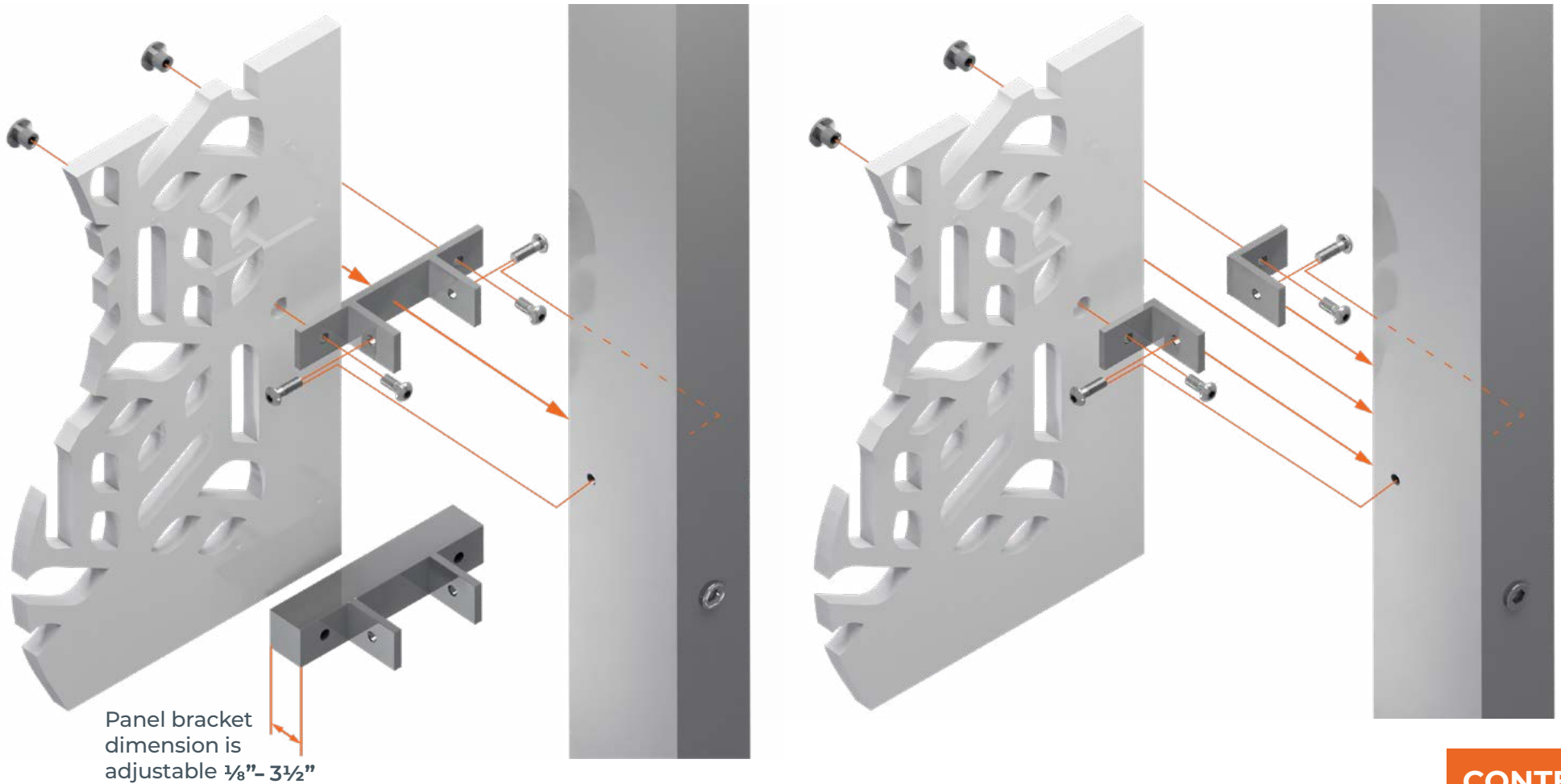

PANEL RAIL™ SYSTEM

FRAMELESS PANEL MOUNTING TO THE POST



 www.liversbronze.com
 Railings@LiversBronze.com
 816-300-2828

CONTENT

14

PANEL RAIL™ SYSTEM

FRAMED PANEL MOUNTING TO THE POST

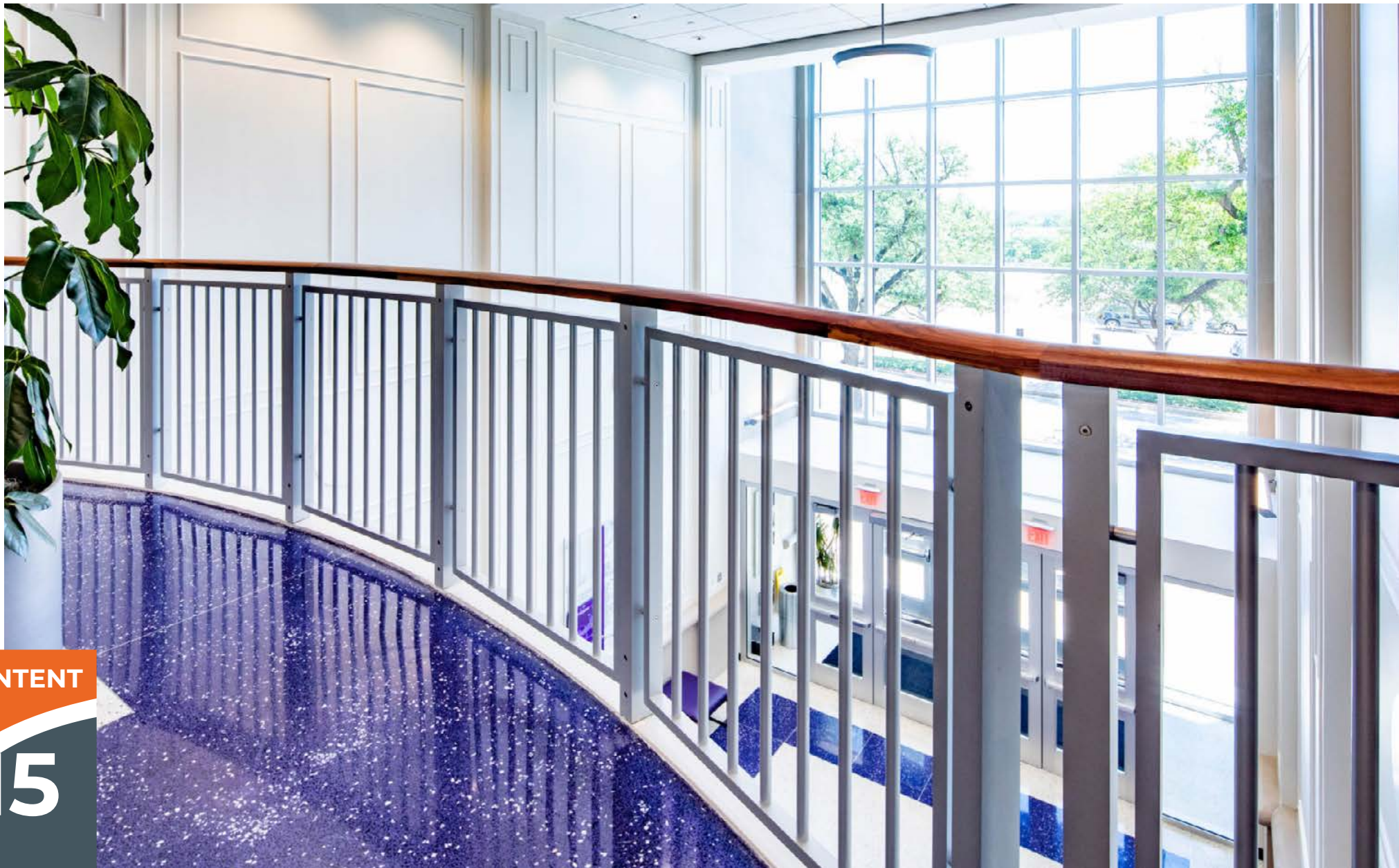

CONTENT

15

PANEL RAIL™ SYSTEM

FRAMED PANEL MOUNTING TO THE POST

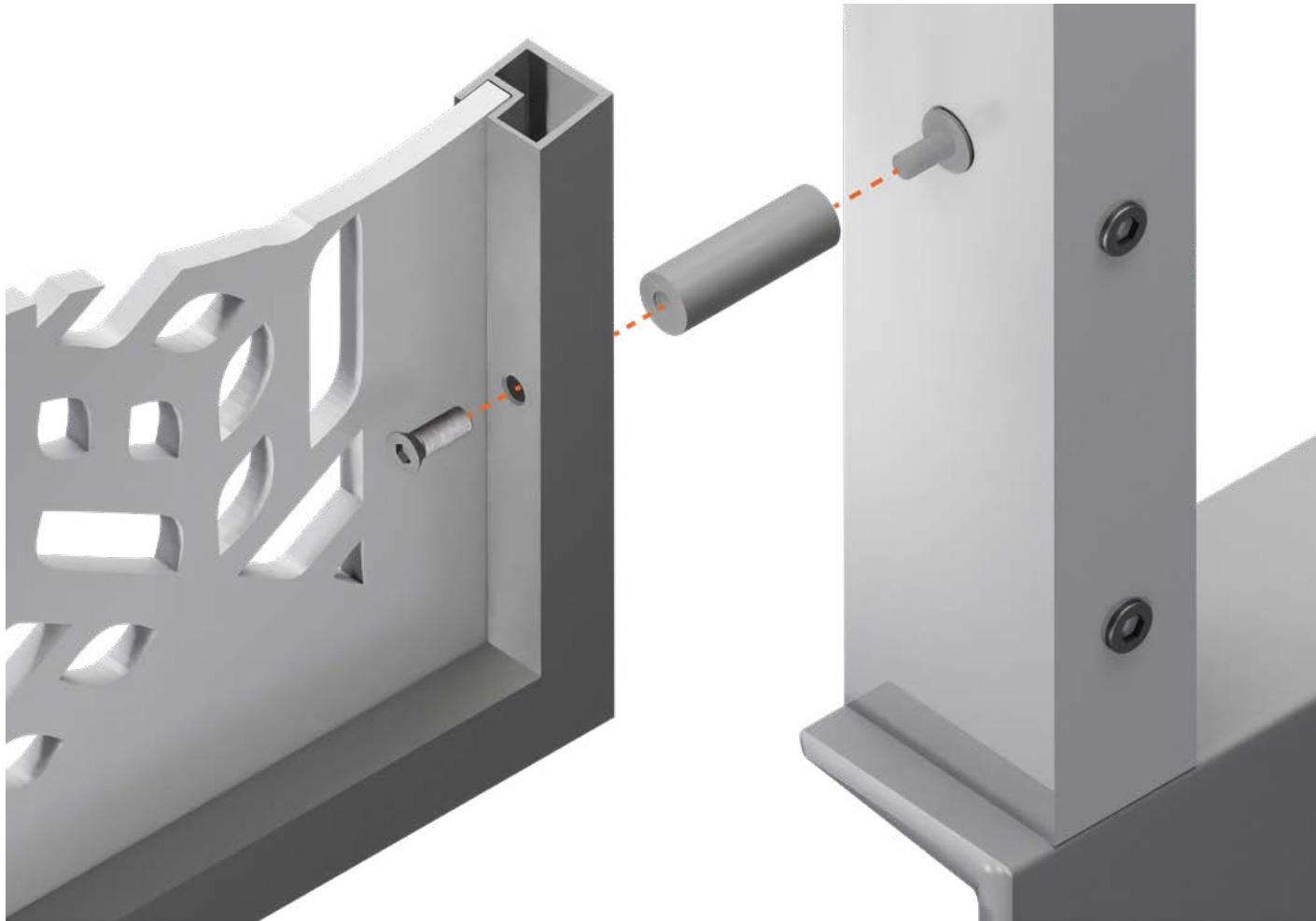

FRAMED PANEL MOUNTS TO POST WITH (4) ROUND SPACERS PER PANEL. LENGTH CUSTOMIZED TO MEET THE PROJECT REQUIREMENTS.

PANEL DESIGN OPTIONS

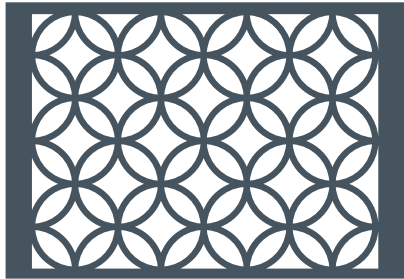

100



200

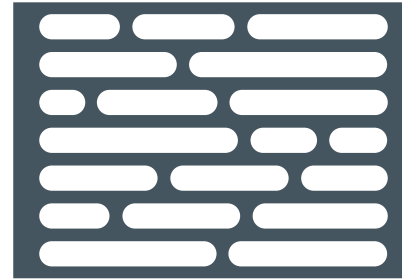

300

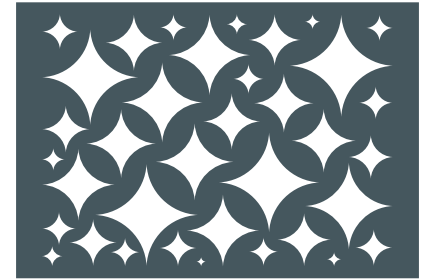

400

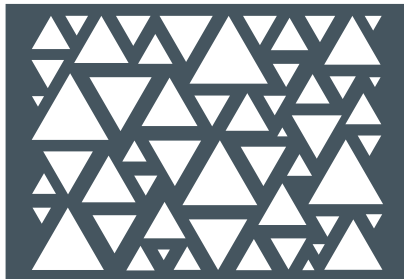

500

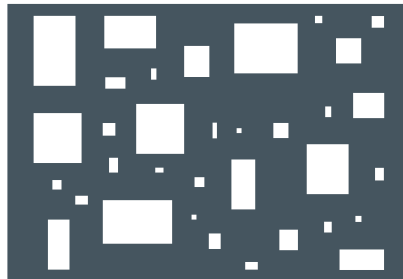

600

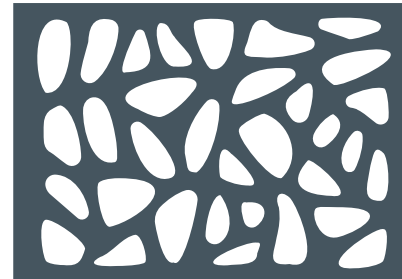

700



800

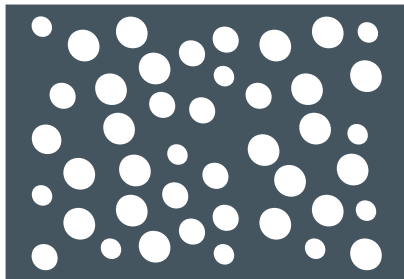

900

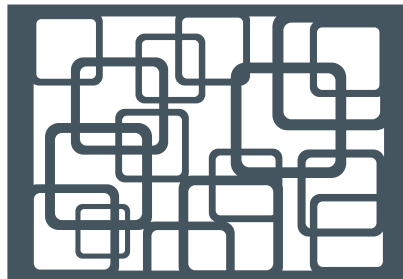

1000



1100

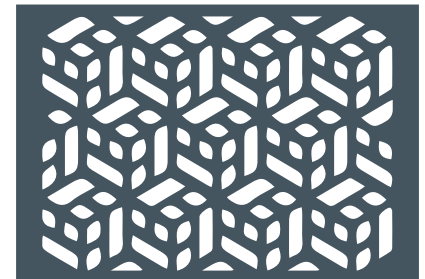

1200

PANEL RAIL™ SYSTEM

PANEL DESIGN OPTIONS

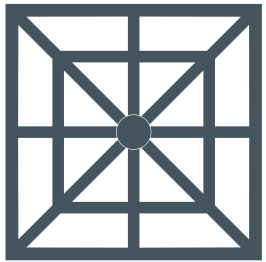

18W

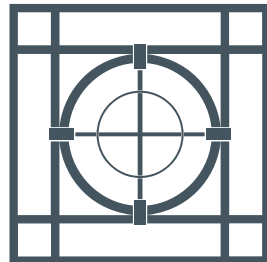

19

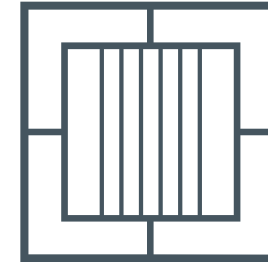
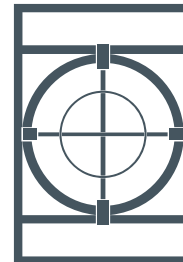

20



21



23



31



35



36





42



SUGGESTED PATTERNS SHOWN - CUSTOM
PANEL DESIGNS ARE ENCOURAGED.



 www.liversbronze.com
 Railings@LiversBronze.com
 816-300-2828

CONTENT

18

PRODUCT DESCRIPTION

AUXILLARY RAILINGS

Livers Bronze Single Line Railings and Wall Mounted Railings are the obvious companions to any project. Available in all metals and finishes these railings are fabricated to perfectly match the companion railing system. Multiple mounting options for both interior and exterior applications make these railings useful and required throughout your project. To push these railings to another level consider using Livers Bronze ILLUME LED railings – you can customize the layout any way that suits your project requirements. All Livers Bronze railings are made in the USA from the industry leader with over 75 years of experience.

Free standing, Wall mounted, Loop railings, Step railings, Site railings, Single line railings, ramp railings, ADA railings, Cane railings and Double line railings are all available.



CONTENT

19



www.liversbronze.com



Railings@LiversBronze.com



816-300-2828

PRODUCT DESCRIPTION

LED RAILINGS



What makes LED railings from Livers Bronze truly exceptional is their adaptability to all Livers Bronze railing systems. Whether these railings are freestanding, wall mounted or attached to another Livers Bronze Railing system - the LED railing can be effortlessly integrated. This seamless compatibility ensures that you can maintain design consistency throughout your project while enjoying the benefits of energy-efficient LED lighting. LED railings from Livers Bronze are available in linear form or individual puck lighting along with multiple beam spreads and color temperatures. For more information contact Livers Bronze – the specialist in all things railing.



www.liversbronze.com



Railings@LiversBronze.com



816-300-2828

CONTENT

20

PANEL RAIL™ SYSTEM

LED RAILINGS



CONTENT



21

PANEL RAIL™ SYSTEM

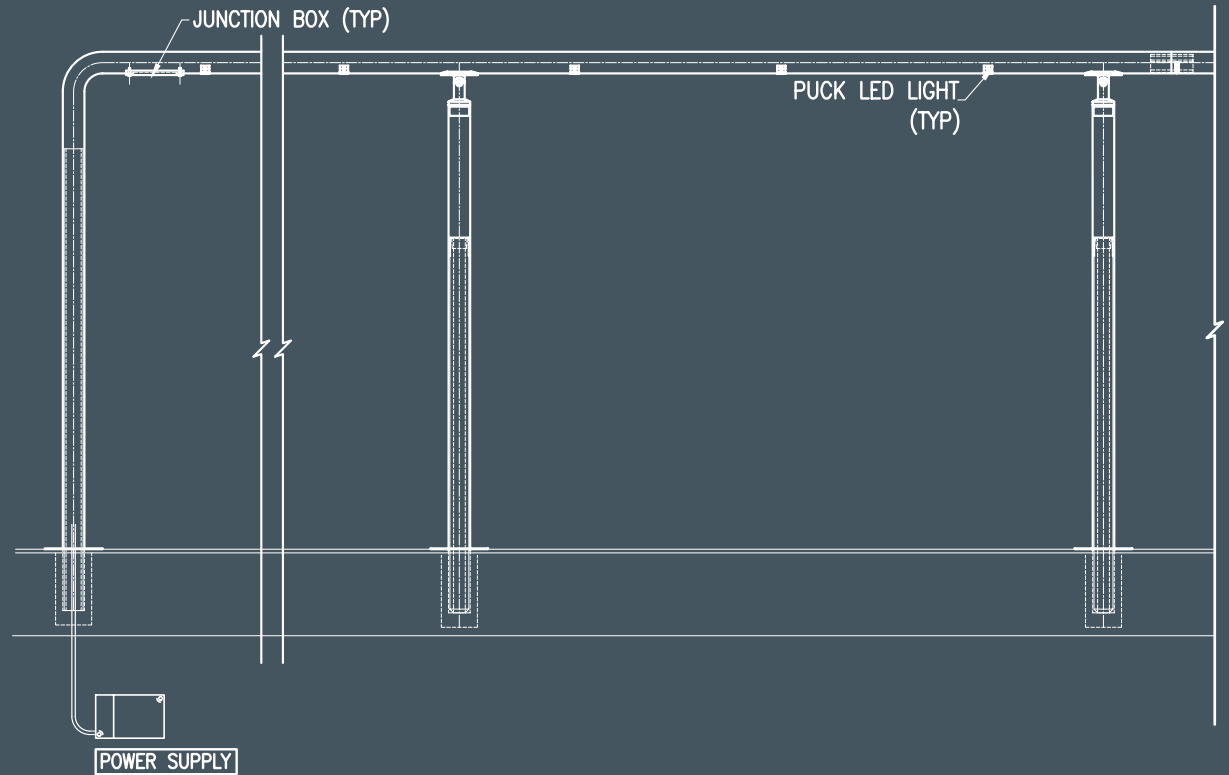
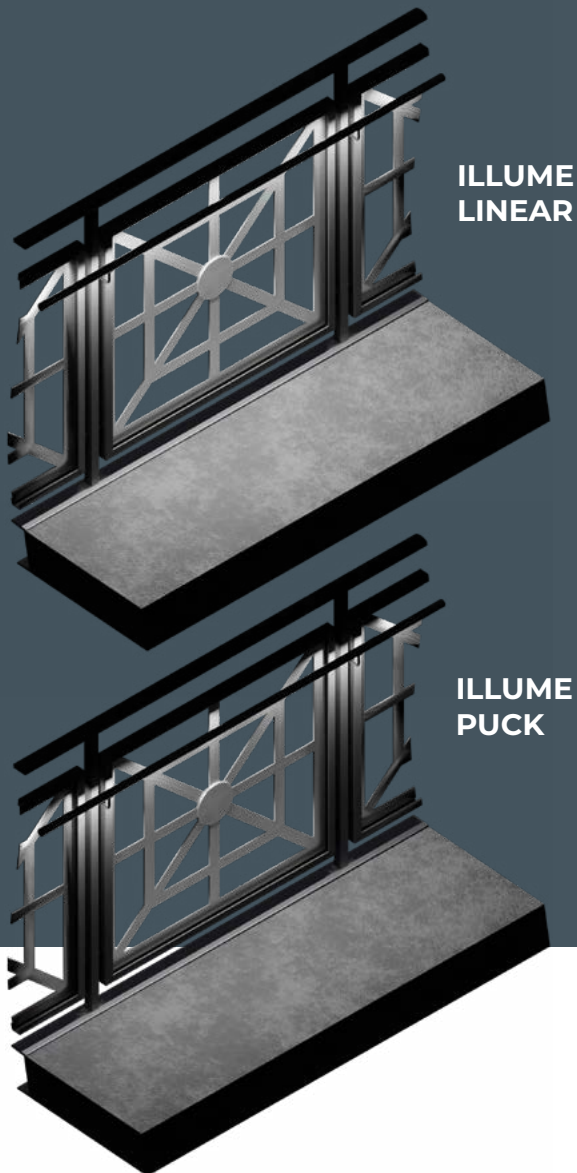
LED RAILINGS



 **LIVERS
BRONZE**

 www.liversbronze.com
 Railings@LiversBronze.com
 816-300-2828

CONTENT

22



PANEL RAILTM

SYSTEM

Livers Bronze LLC

4621 East 75th Terrace
Kansas City, MO 64132



Phone: 816-300-2828 www.liversbronze.com